

TOX[®]-ElectricPowerDrive Type EXe-L

Data sheet 40.25
2023/06



TOX[®]-Electric Power Module

Type EXe-L 300 – 1000 kN with planetary roller screw

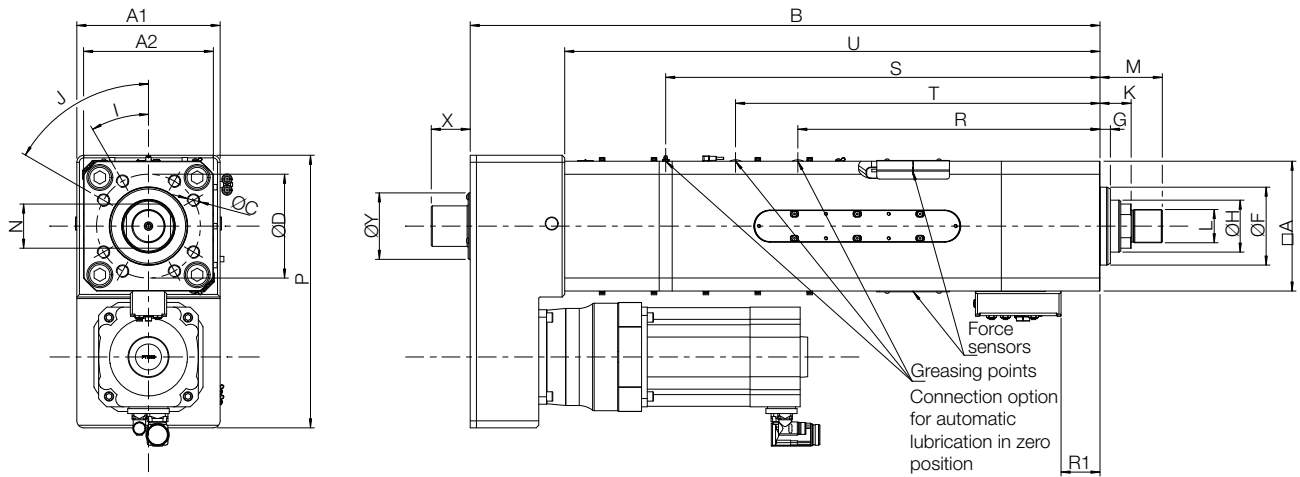

Dimensions and weights

Type	Stroke mm	Max. Nominal force kN	Weight approx. kg
EXe-L 300.003.300	300	300	449
EXe-L 400.003.300	300	400	481
EXe-L 500.003.300	300	500	831
EXe-L 700.003.300	300	700	1009
EXe-L 1000.003.300	300	1000	1173

Type	A	A1	A2	B	C	D	F ₁₇	G	H	I	J	K ¹⁾	L	M ¹⁾	N ¹⁾	P	R	R1	S	T	U	V ₉₆	W	X	Y
EXe-L 300.003.300	250	276	250	1218	8xM24x40	200	150	20	100	30°	60°	60	M64x2	120	85	525	582	100	836.5	702	1031	-	-	60	114
EXe-L 400.003.300	250	276	250	1260	8xM24x40	200	150	20	100	30°	60°	60	M64x2	120	85	525	432	100	801.5	552	1074	-	-	60	114
EXe-L 500.003.300	315	330	321	1435	8xM24x48	250	200	20	125	30°	60°	60	M64x2	120	100	610	537	100	946.5	657	1243	-	-	80	110
EXe-L 700.003.300	315	330	321	1651	12xM24x48	250	200	20	150	30°	60°	60	M80x2	140	125	610	622	100	1066.5	742	1459	-	-	80	110
EXe-L 1000.003.300	340	355	340	1693	12xM24x48	250	200	20	150	30°	60°	60	M80x2	140	125	695	622	100	1091.5	742	1456	-	-	80	110

¹⁾ Dimension refers to reference position of drive. Zero position is reference position + 3mm.

Dimensions in mm

Specifications EXE-L	300.003.300	400.003.300	500.003.300	700.003.300	1000.003.300
Mechanical					
Nominal pressing force	300 kN	400 kN	500 kN	700 kN	1000 kN
Nominal pulling force	300 kN	400 kN	500 kN	700 kN	500 kN
Stroke ¹⁾	300 mm	300 mm	300 mm	300 mm	300 mm
Max. speed ¹⁾	90 mm/s	75 mm/s	65 mm/s	48 mm/s	38 mm/s
Distance repeatability ²⁾	0.01 mm				
Max. tool weight without brake ⁴⁾	150 kg	150 kg	150 kg	150 kg	150 kg
with safety brake ⁵⁾	2000 kg	2000 kg	2000 kg	2000 kg	2000 kg
Sensors					
Force transducer measuring range ³⁾	3 – 300 kN	4 – 400 kN	5 – 500 kN	7 – 700 kN	10 – 1000 kN
Accuracy	< +/- 0.5 % of rated force, pressing				< +/- 1.0 % of rated force, pressing
Resolver	■	■	■	■	■
Resolution (theoretically)	0.0015 mm	0.0015 mm	0.0015 mm	0.0015 mm	0.0025 mm
Electrical					
Protection class	Drive IP54 (as component)				
Mains supply	see data sheet 40.15 System & Components				
Climatic conditions	+ 10° to + 40° C, from 40° C performance loss, max. 55° C; air moisture < 75 %, without condensation				
Cooling	–	–	Motor with fan	Motor with fan	Motor with fan

¹⁾ Specials on request (colour, stroke, speed, ...)

²⁾ In thermal transient condition

³⁾ Recommended operating range 1 – 100 %

⁴⁾ For higher weights, the tool can sink in de-energized condition

⁵⁾ Higher tool weights on request

TOX[®]-EdgeUnit

TOX[®]-EdgeUnit is the decentralized intelligence for each TOX[®]-ElectricPowerDrive

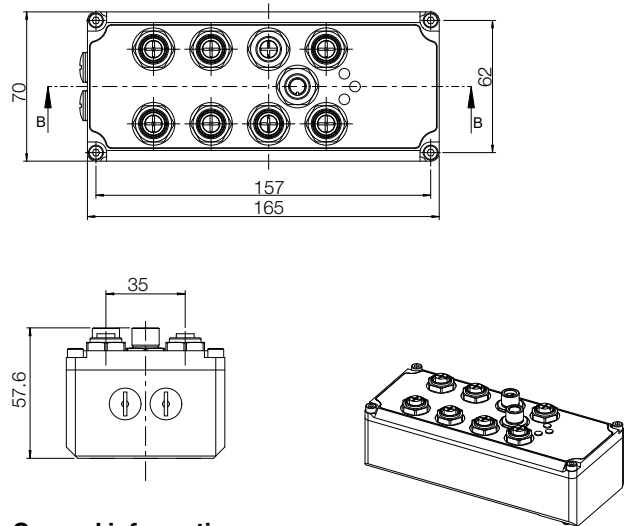
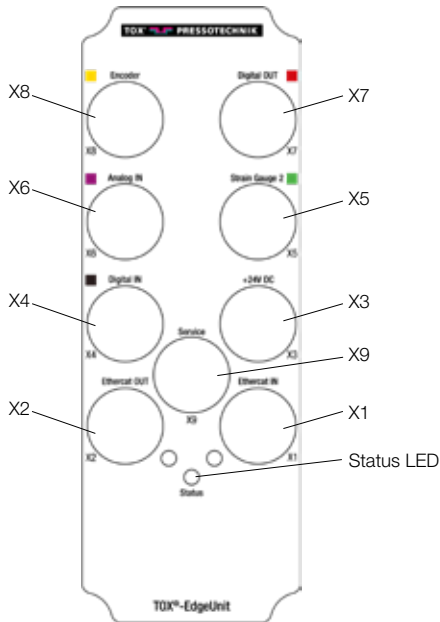

General information:

- Ambient temperature: 0 ... 50°C
- IP protection: IP 65 (plug closed)
- Housing: aluminum
- Status LED shows different states of the TOX[®]-EdgeUnit
- Integrated memory

Technical data/interfaces

X1 ■	Ethercat IN, incl. status LED
Pin assignment	M12 4-pin Bushing, D-coded
X2 ■	Ethercat OUT, incl. status LED
Pin assignment	M12 4-pin Bushing, D-coded
X3	Power supply
Voltage	+ 24VDC (18 ... 28 VDC)
Current draw	US1 <0,25A (without loads at Pin1, X4-7) US2 ~0A (without outputs at X7)
US1 US2	Logic voltage + sensors Output voltage (not electrically isolated)
Pin assignment	M12 5-pin, plug A-coded
X4 ■	Digital IN
Digital IN 1 / Digital IN 2	24VDC
Logic level 0 (LOW)	0V ... 10V
Logic level 1 (HIGH)	16V ... 28V
Input current	max. 2 mA (at 24V)
Pin assignment	M12 5-pin bushing, A-coded
X5* ■	Strain Gauge 2
Measuring range	1.157 mV/V – 3,25 mV/V (intensifier adjustable)
Voltage VDC	5V
Shunt resistor	typ. 700 Ω
Resolution	16 Bit
Pin assignment	M12 5-pin bushing, A-coded

X6* ■	Analog IN
Analog IN 1	-10 ... 10VDC, 16 bit
Analog IN 2	0 ... 10VDC, 12 bit
Pin assignment	M12 5-pin bushing, A-coded
X7 ■	Digital OUT
Digital OUT 0 / Digital OUT 1	24VDC, US2
Output current	max. 2 A (per channel) / overcurrent and short-circuit proof
Pin assignment	M12 5-pin bushing, A-coded
X8* ■	Encoder
Pin assignment	M12 8-pin bushing, A-coded
X9	Service pin
Pin assignment	M12 8-pin Plug, A-coded

*Compatible sensor types available on request

M12 pin assignment

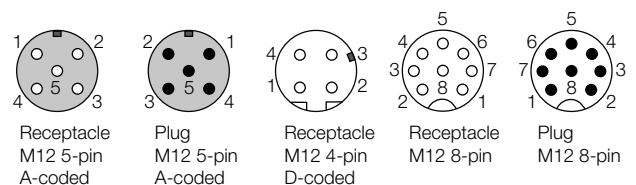

Pin assignments

EdgeUnit

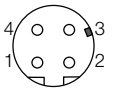
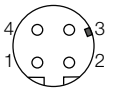
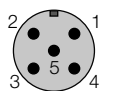
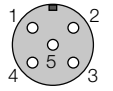
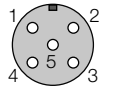
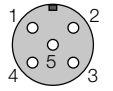
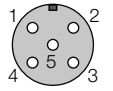
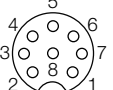
Version	Designation	Description
X1 Receptacle 4-pin, D-coded 	EtherCat In	Pin 1 = TD+ Pin 2 = RD+ Pin 3 = TD- Pin 4 = RD-
X2 	EtherCat Out	Pin 1 = TD+ Pin 2 = RD+ Pin 3 = TD- Pin 4 = RD-
X3 Plug 5-pin, A-coded 	Power	Pin 1 = 24V US2 Pin 2 = GND US2 Pin 3 = 24V US1 Pin 4 = GND US1 Pin 5 = PE GND US1 = GND US2 = GNO
X4 Receptacle 5-pin, A-coded 	Digital In	Pin 1 = 24V US1 Pin 2 = DIN2 24V Pin 3 = GND Pin 4 = DIN1 24V Pin 5 = PE
X5 	Strain Gauge 2	Pin 1 = Strain Gauge Sig (neg) Pin 2 = 5V Strain Gauge Ref Pin 3 = GND Pin 4 = Strain Gauge Sig (pos) Pin 5 = -
X6 	Analog In	Pin 1 = 24V US1 Pin 2 = AIN2 0 ... 10V Pin 3 = GND Pin 4 = AIN1 -10 ... 10V Pin 5 = PE
X7 	Digital Out	Pin 1 = 24V US1 Pin 2 = DOUT1 24V US2 (2A) Pin 3 = GND Pin 4 = DOUT0 24V US2 (2A) Pin 5 = PE
X8 Receptacle 8-pin 	Encoder	Pin 1 = 5V Pin 2 = APR Pin 3 = ANR Pin 4 = BPR Pin 5 = BNR Pin 6 = CPR Pin 7 = CNR Pin 8 = GND

Motor fan

Pin	Designation	Description
1	230V	Fan on V+
2	0V	Fan off V-
4		Not assigned
5		Not assigned
PE	PE	Protective conductor

Type: Intercontec M17/7-pin

Motor/Motor holding brake (optional)

Pin	Designation	Description	Plug
U	U	Power leg U	
+	BD1	Immobilisation brake +	
-	BD1	Immobilisation brake -	
W	W	Power leg W	
V	V	Power leg V	
PE	PE	Protective conductor	
1		Not occupied	
2		Not occupied	

Type: Intercontec ICN-M40, 8-pin

Resolver

Pin	Designation	Description	Plug
1	+Ref	Transformer windings	
2	-Ref	Transformer windings	
3	+VCC ETS	Not assigned	
4	+COS	Stator winding Cosinus	
5	-COS	Stator winding Cosinus	
6	+SIN	Stator windings Sinus	
7	-SIN	Stator windings Sinus	
8		Not assigned	
9		Not assigned	
10	Shield	Housing shield of transmitter	
11	+	Temperature monitoring: PT1000	
12	-	Temperature monitoring: PT1000	

Type: Intercontec ICN-M23, 12-pin

Safety brake (optional)

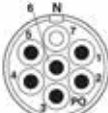
Pin	Designation	Description	Plug
1	24V	Release brake V+	
2	0V	Release brake V-	
3	24V	Sensor V+	
4	0V	Sensor V-	
5	S + 24V	Sensor signal release brake	
6	N.C.		
7	N.C.		

Type: Intercontec ASDA157FR12580150400, 7-pin

Lifetime L10

The lifetime L10 is a complex calculation. The following factors influence the lifetime L10, in some cases considerably:

- Rate of force application
- Powerstroke
- Punching impact
- Application
- Revolutions per minute

Schematic illustration of the lifetime L10

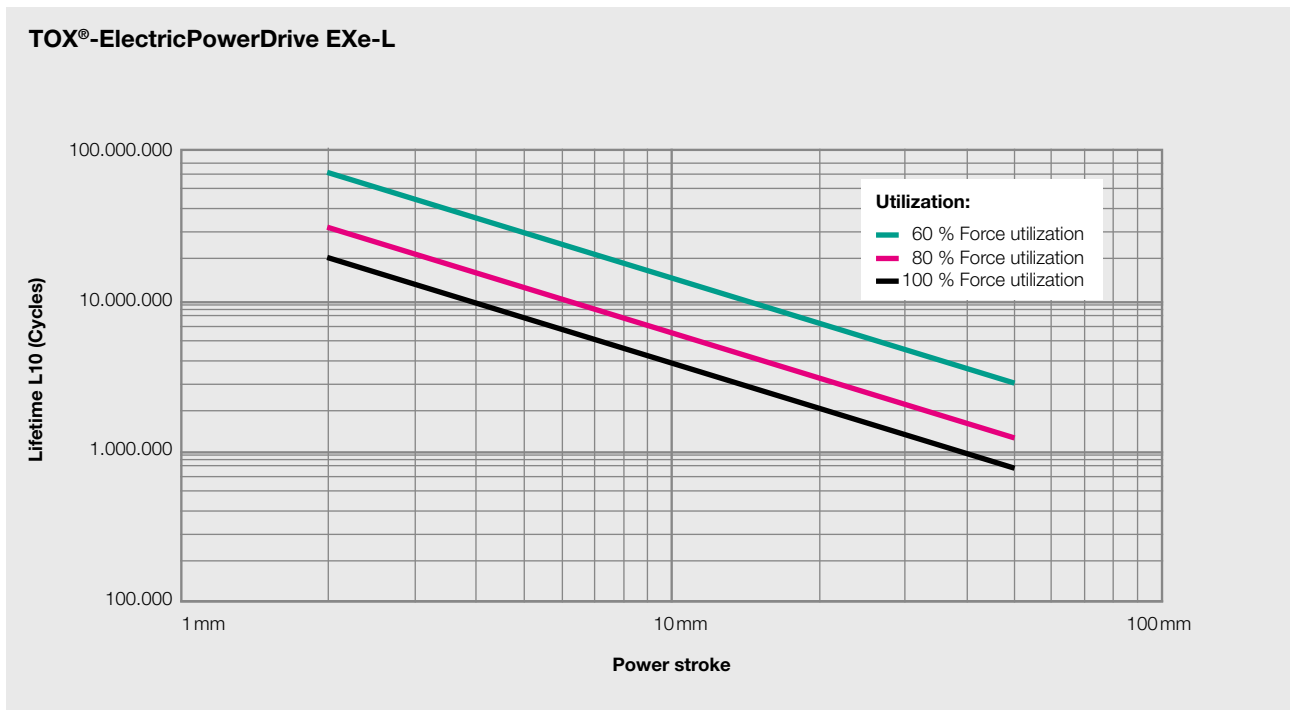

We are happy to carry out the lifetime calculation for your application. Just ask us!