

TOX®  PRESSOTECHNIK

# TOX® - Clinching-Technology

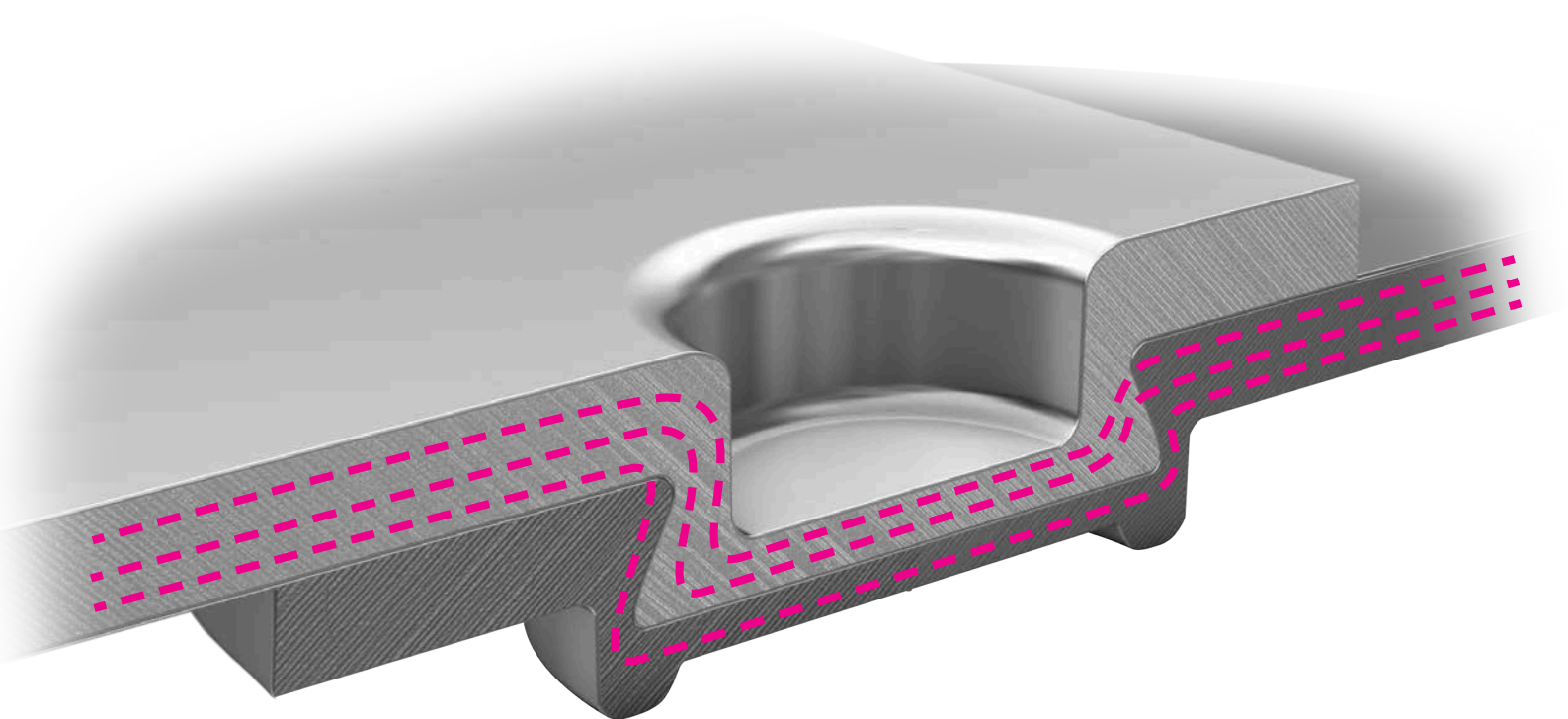

# TOX®-eClinching-Technology

---

## Power point with low resistance

Like conventional clinching, TOX®-eClinching provides the advantages of very high retaining forces and easy quality monitoring, alongside excellent electrical conductivity. For this reason, the term TOX®-eClinching summarizes know-how, process competence and the technical systems required for the production of durable electrically-conductive connections.

The clinching procedure is ideally suited to the production of electronic components. Possible applications include LED traces, fuses and the contacts of battery cells.

Compared to conventional soldered, welded and screwed connections, TOX®-eClinching provides a better alternative, as the surfaces do not require pretreatment and the process does not need any heat input.

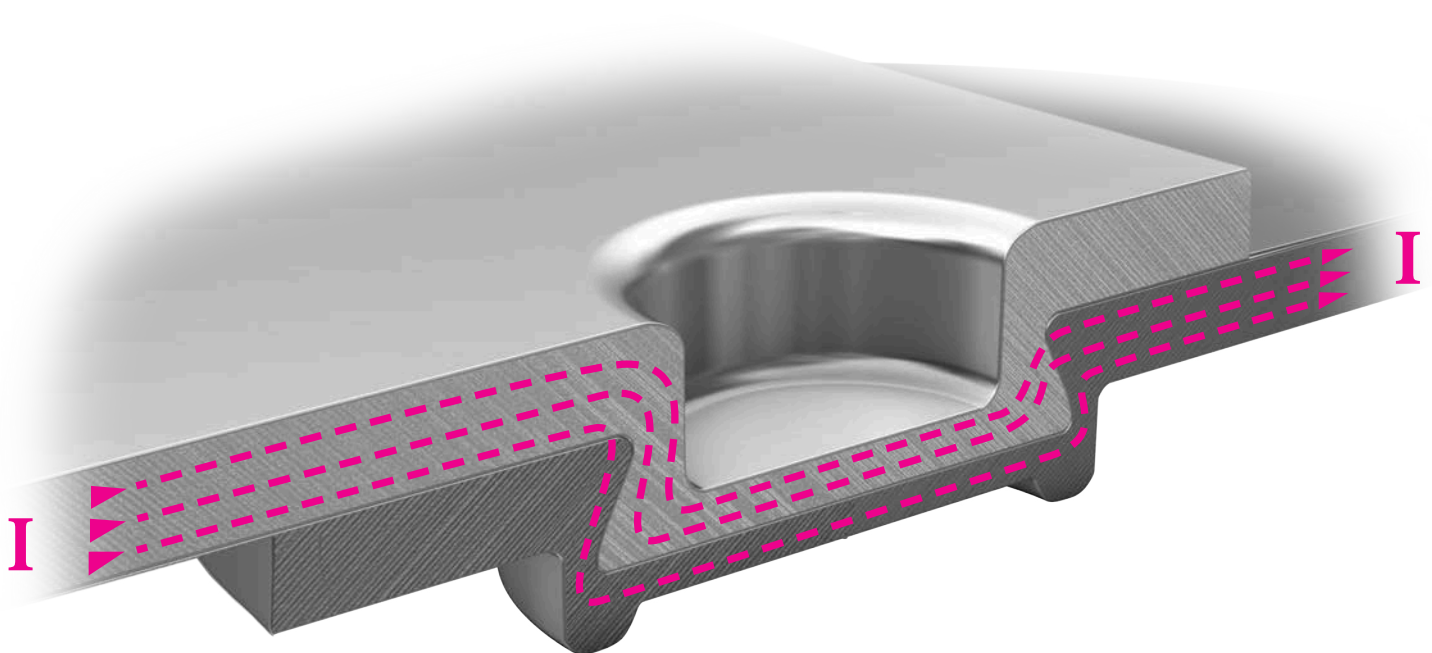

TOX®-eClinching creates excellent, electrically-conductive connections through metallic microcontacts.

# Process Competence

## Creation of conductivity

During TOX®-eClinching, a punch presses the sheets to be joined into a die. The undercut created by the plastic deformation ensures high retention forces in the neck area. An electrical connection is also created with excellent conductivity.

### Joint zone with optimal material bonding

During the clinching process, in addition to the positive locking and frictional connection, there is also partial material bonding in the joint zone: The joined sheets flow into each other in such a way that an optimally conductive joint is created with the lowest possible contact resistance due to a large number of micro-contacts.



### Enlarged contact surface

The effective contact surface is almost doubled with the clinch forming process. It increases more significantly in thicker materials. This expanded surface area also increases the conductivity of the joint.

### Flowing coatings

Soft coatings, for example tin coatings on copper, flow without removal while being thinned to a few µm in thickness. The conductivity is maintained.

Areas with the best material bonding

-  very high (neck area)
-  high (base)
-  good

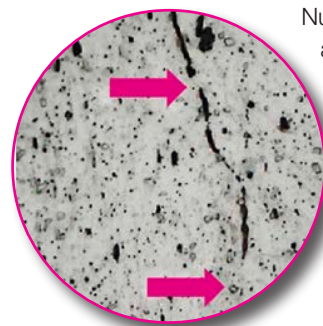
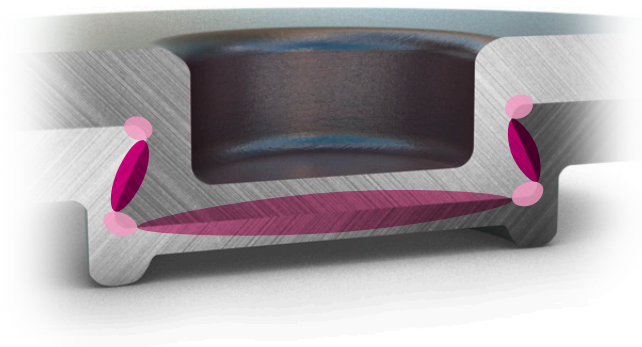

Numerous microcontacts assist in the conductive connection of the materials.

Source: TU Dresden

Comparison of contact surfaces							
Point nominal diameter	2 mm	2 mm	2 mm	5 mm	5 mm	6 mm	8 mm
Sheet thickness on punch side	0.35 mm	0.80 mm	0.30 mm	0.50 mm	0.60 mm	0.35 mm	1.15 mm
Sheet thickness on die side	0.50 mm	0.60 mm	0.30 mm	0.50 mm	0.60 mm	0.80 mm	1.15 mm
Level reference plane	4.91 mm <sup>2</sup>	4.91 mm <sup>2</sup>	4.91 mm <sup>2</sup>	28.3 mm <sup>2</sup>	28.3 mm <sup>2</sup>	38.46 mm <sup>2</sup>	63.58 mm <sup>2</sup>
Resulting contact surface	7.67 mm <sup>2</sup>	7.87 mm <sup>2</sup>	7.72 mm <sup>2</sup>	42.55 mm <sup>2</sup>	44.02 mm <sup>2</sup>	53.80 mm <sup>2</sup>	107.8 mm <sup>2</sup>
Increase of contact surface	56 %	60 %	57 %	50 %	55 %	39 %	69 %

Source: TU Dresden

# Process Competence

## Permanently low contact resistance

TOX®-eClinching is an efficient technology to join electrically conductive components safely and permanently, both mechanically and electrically.

### Constant conductivity with high retention forces

As clinch connections safely withstand mechanical stresses (e.g. torques) and temperature changes in the long-term, when compared to other joining processes, the relaxation of the connection is not a significant factor. The contact resistance will therefore be constantly low, and the high conductivity will be maintained. This makes the procedure ideally suited to meet the high demands of the electrical industry.



### Relaxations in the contact area

A TOX®-eClinch Point remains safely in the stable range (green point). Joint relaxation, which is principally unavoidable, is insignificant and practically not quantifiable.

If the process-specific characteristics are not observed, there is a risk of entering the unstable range (red point).

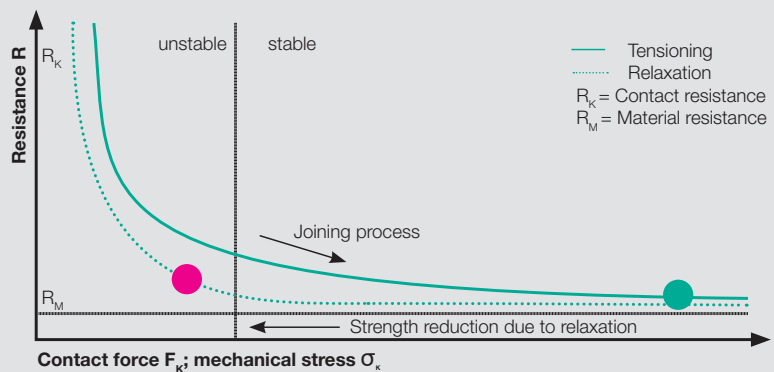

### Tolerant procedure

To ensure electrical connection, it is important to consider crucial steps in the design phase. Perfect joint formation with an ideal remaining bottom thickness and the resulting high conductivity can only be achieved by using optimized TOX®-eClinching tools. Even with multi-material clinch joints, the contact resistance does not increase significantly and the high conductivity is maintained.

### Contact resistance with tool misalignment

TOX®-eClinching points were measured in tests with increasing offset, and the contact resistance was measured. The result: The high conductivity is maintained even for off-center clinching points.

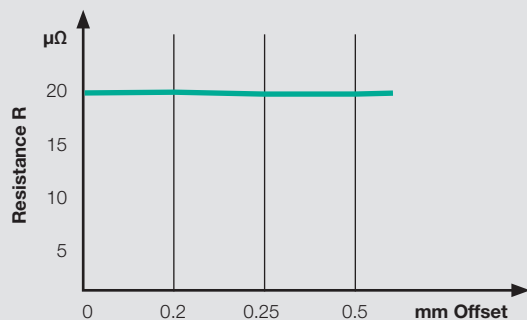

Materials  
 Punch side: Cu ETP R290 sheet thickness 0.8mm  
 Die side: Cu ETP R290 sheet thickness 0.8mm



# Process Competence

## Flexible installation possibilities

### Precision in serial production

With exact placement of the technology in a production tool, the TOX®-eClinch Points can be precisely positioned on the piecepart. Process monitoring checks the joining process to ensure the high quality of the connections.

### Consistent dynamic strength

In comparison to spot welding, the clinching process does not have the negative properties of the notch effect. This allows the joint strength to remain constant over various load cycles.

### Control dimension X guarantees conductivity

The remaining bottom thickness of a joint affects the electrical conductivity. As TOX®-eClinching enables simple quality monitoring for series production, the continuous measurement of the control dimension X ensures the consistent conductivity of the connection.

### Flexible with regard to material combinations

Different material combinations – including those that cannot be soldered or welded – can be joined with the TOX®-eClinching technology. For example, aluminum and copper are a common combination in battery modules and can be joined without creating an isolating intermetallic phase. It is also ideally suited to the joining of sensitive battery cells without heat input.

## Advantages

- Frictional connection, positive locking and material bonding in one process
- Highly robust connections
- No pretreatment required
- Joining without heat input
- Very low contact resistance
- Comprehensive documentation of the relevant process data

### The remaining bottom thickness correlates to the contact resistance

The remaining bottom thickness of a TOX®-eClinch Point is called control dimension X.



Compliance with this dimension is important, as the greater the remaining bottom thickness, the higher the resistance.

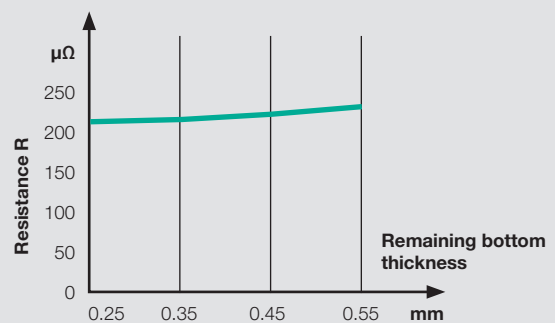

Materials  
 Punch side: Al 1050, sheet thickness 1.2 mm  
 Die side: Cu 5210, sheet thickness 0.4 mm

## TOX®-eClinching joins

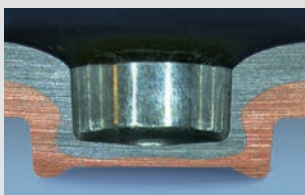

Aluminum in copper

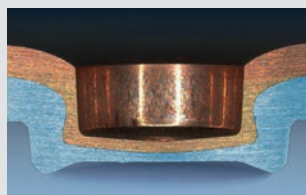

Copper in aluminum

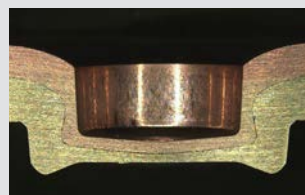

Copper in brass

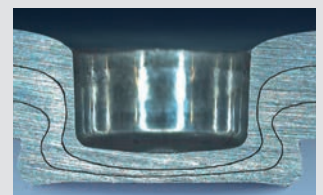

Steel in steel and many others.

# Process Competence

## The perfect TOX®-eClinch Point for every application

### With know-how for maximum conductivity

To ensure electrical conductivity in the long-term, some design principles must be observed in the selection and design of the tools. The basis is the TOX®-Clinch-Point shape, which is optimized to achieve the desired material bonding.

The following point shapes are available as conductivity-optimized versions for TOX®-eClinching:

### TOX®-eRound-Joint

The classic: A round punch presses the materials to be joined into the round solid die. The result is an aesthetically pleasing round button, which joins cleanly without any burrs or sharp edges on the sheet metals.

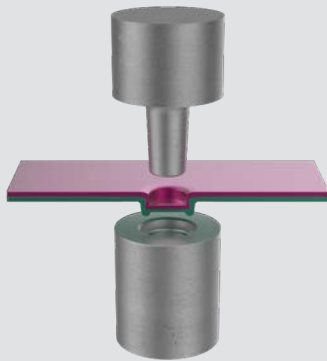

### TOX®-eSKB

The special die consists of solid and movable segments. The solid segments center the material and the punch. The movable elements allow flow behind the material in the joint.

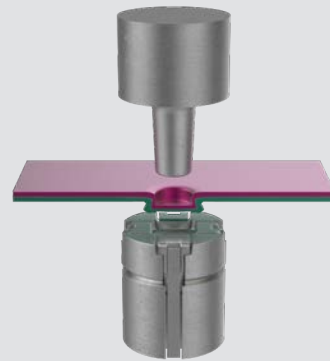

### TOX®-eMICROpoint

The miniature TOX®-Round-Joint is our answer to component miniaturization. With a diameter of 2mm, it is ideal for sheet metal thicknesses of 0.2 – 0.5 mm. As an eClinch joint it is ideal for joining small components, as it ensures proper material bonding along with a small diameter.

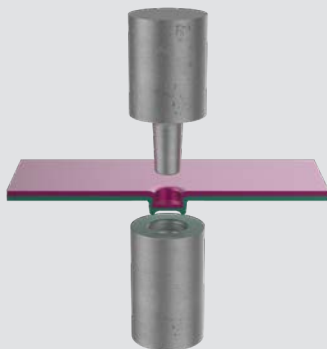

### TOX®-eTWINpoint

This double joint version provides protection against rotation and increases the joint strength compared to the single joint. Therefore, it is ideal for eClinching to counteract mechanical relaxation.

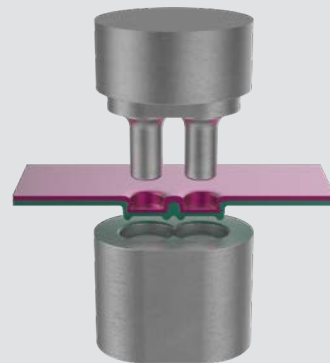

# Application examples

**Components** as application examples for TOX®-eClinching

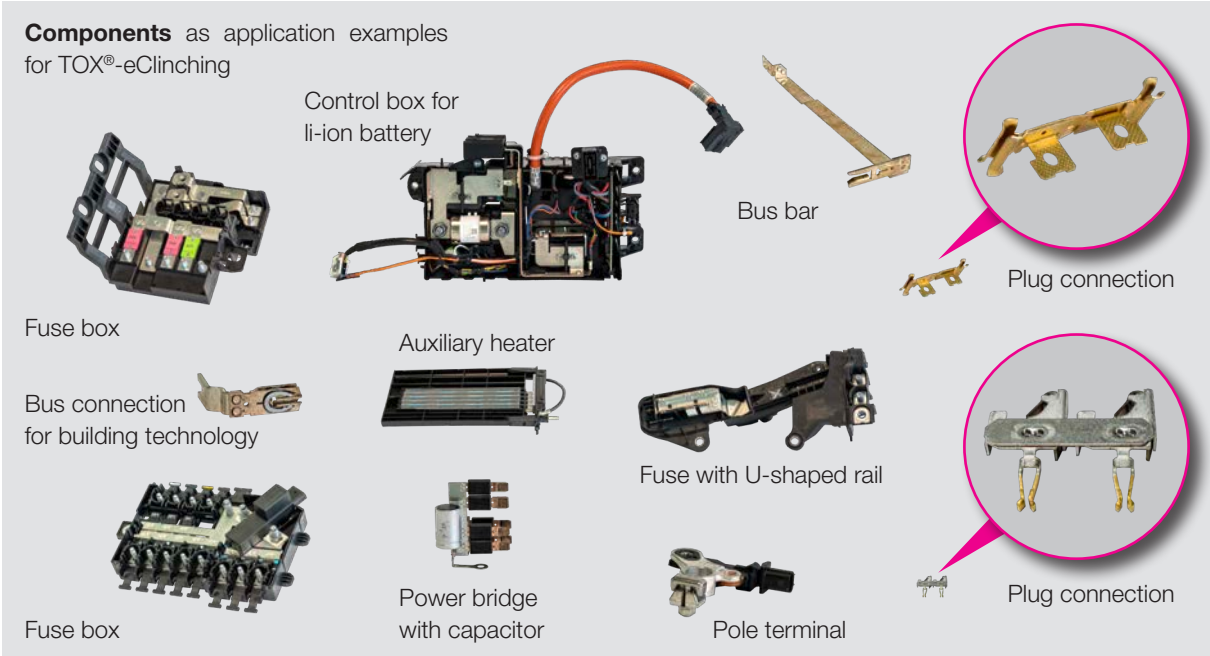

**TOX®-Press** for the joining of fuses and sheet metal parts.



**TOX®-FinePress** for the joining of electric parts with a TOX®-MICROpoint.

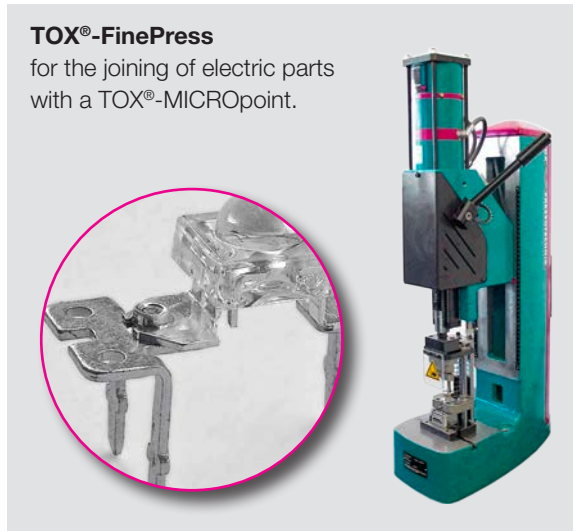

**TOX®-Press Station** for eClinching of fuse components.



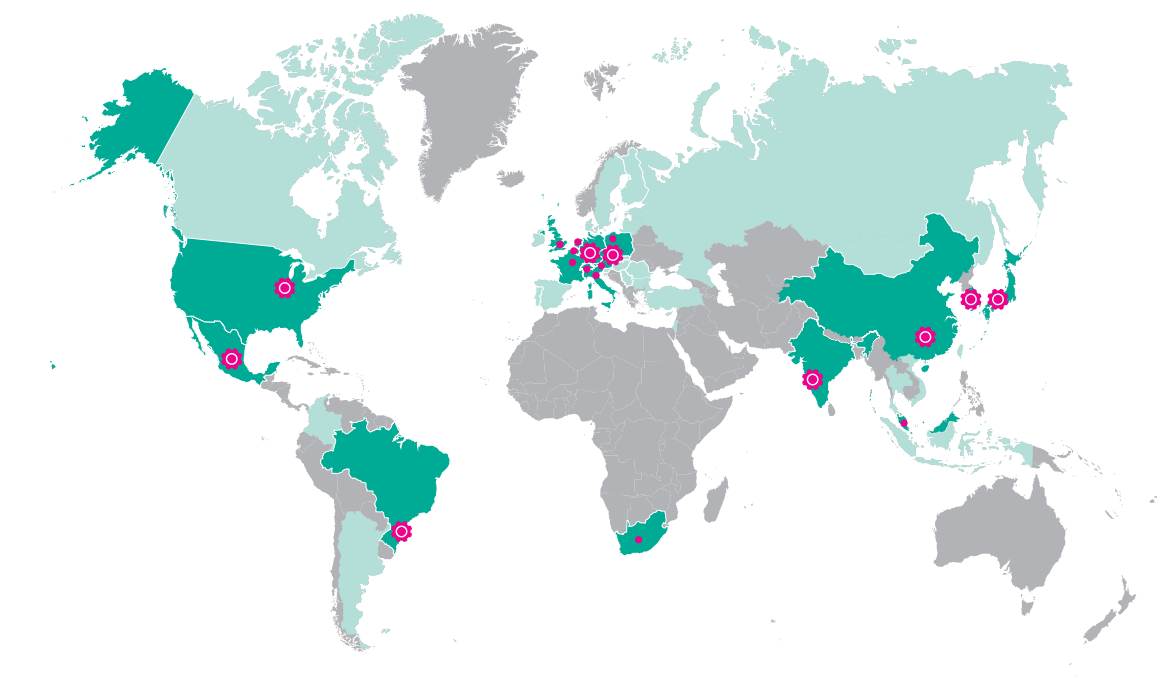

**TOX®  PRESSOTECHNIK**

TOX® PRESSOTECHNIK GmbH & Co. KG  
Riedstrasse 4  
88250 Weingarten / Germany

Find your local contact partner at:  
[tox-pressotechnik.com](http://tox-pressotechnik.com)

792848 / 81.202002.en Subject to technical modifications.